

Royal Mail Mailmark®

eManifest Handling System (eMHS) Customer Upload Interface Specification

Issue:

10th September 2021

First Issued:

24th September 2020

Version

1.6

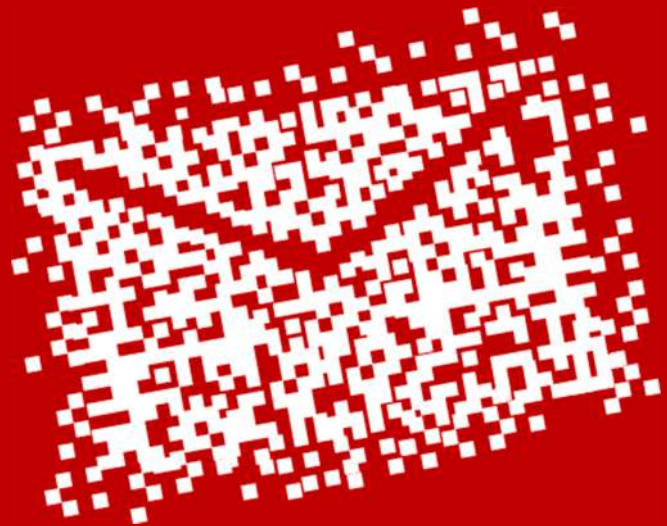

Update to this document 10th September 2021

Page 49. ResponseMailType optionality changed from Optional to Mandatory.

Update to this document 31st May 2021

Pages 11,13,14,23,27 and 63. Note added referencing that Retail deferred functionality is not currently in use.

Update to this document 11th May 2021

Pages 11,26 and 32. 14 days referenced instead of 28 days re: upload timing options.

Update to this document 1st April 2021

Royal Mail's HQ address changed

Updates to this document 15th February 2021

1. Page 45 (Format). Additional highlight
Please note: it is a mandatory requirement to select the 'format'
2. Page 47 (Machineable). Additions
 - N = reserved for future use
 - Note: 'E' must be selected for Mailmark General Large Letters and Parcels.
3. Clarity around the use of Service Type, Format values and machineability for Parcels and General Large Letters.

Service Type (2D barcode)	Format Values (4state barcode)	Machinability (eMHS)
0 - Mailmark Letter	0 - Null	E - Mailmark
1- Mailmark Large Letter	1 - Mailmark Letter	N - reserved for future use
2 - reserved for future use	2 - Mailmark Large Letter	
3 - reserved for future use	3 - reserved for future use	
4 - Parcel	4 - Parcel	

Please note GLL and Parcel must both be machinability 'E'.

- a. If posting **Access Parcels** using a 2D barcode would select Service Type 4 within the barcode. You should also select Service Type 4, Format 4 and Machinability E for the eManifest.
- b. If posting **Access Parcels** using a 4-state barcode would select Format Value 4 in the barcode. You should also select Service Type 4, Format 4 and Machinability E for the eManifest.
- c. If posting **manual Mailmark Large Letters**, including existing Mailmark Large Letters, using a 2D barcode would select Service Type 1 in the barcode. You should also select Service Type 1, Format 2 and Machinability E for the eManifest:
- d. If posting **manual Mailmark Large Letters** using a 4-state barcode would select Format Value 2 in the barcode. You should also select Service Type 1, Format 2 and Machinability E for the eManifest:

4state barcode would select Format Value 2 and Machinability E.

Note: Access parcels and General Large Letters are machineable when posted under the '70' way sort product and may be machined under the '1400' way sort product. For simplicity, both 70 and 1400 variants have a machineability value of E.

Updates to this document 24th September 2020

- 1 Page 49. Deleted 3 = 'Packet (for potential future use)'. Replaced with 'not in use'.
- 2 Page 49. Deleted 6 = 'Air (Retail)' and 7 = 'Surface (Retail)' and replaced both with 'not in use'
- 3 Page 49. Added 'E' = Economy (Network Access)
- 4 Page 53. Deleted 3 = 'Packet (for potential future use)'. Replaced with 'not in use'.
- 5 Page 53. Replaced 'Spare' with - 'Not in use'
- 6 Page 53. Deleted 6 = 'Air (Retail)' and 7 = 'Surface (Retail)' and replaced both with 'not in use'
- 7 Page 53. Added 'E' = Economy (Network Access)
- 8 Page 53. Response Mail type. Changed from Conditional to 'Optional'. Reference that this field is referred to as 'Service Type' in the Barcode specification document). Descriptions updated

Updates to this document 8th January 2018

1. Changes to eManifest submission deadlines – (Section 3.5)
2. Changes to Description fields to support JIC – (Section 10.3)
3. Changes to Batch upload timings – (Section 3.1)

Disclaimer

Whilst every effort has been made to ensure that the guidelines contained in the document are correct, Royal Mail and any other party involved in the creation of the document HEREBY STATE that the document is provided without warranty, either expressed or implied, of accuracy or fitness for purpose, AND HEREBY DISCLAIM any liability, direct or indirect, for damages or loss relating to the use of the

document. The document may be modified, subject to developments in technology, changes to the standards, or new legal requirements.



Contents

- 1. Introduction..... 5**
 - 1.1. Purpose..... 5
 - 1.2. Intended Audience 5
 - 1.3. Scope..... 5
 - 1.4. Document Structure..... 5
- 2. Key Features 6**
 - 2.1. Supply Chain 6
 - 2.2. eManifest 8
 - 2.3. Batches 9
- 3. Process Overview 10**
 - 3.1 Submitting an eManifest to Royal Mail..... 10
 - 3.2 Step 4 - Raising 'Spoils' for a Batch 11
 - 3.3 Step 5 - Submitting a Batch of Mailmark items..... 11
 - 3.4 Step 6 - Confirming the eManifest..... 11
 - 3.5 Timings 13
 - 3.6 Other Actions 14
 - 3.6.1 Cancelling Batches 14
 - 3.6.2 Rescheduling Batches 14
 - 3.7 eManifest Submission Options 15
- 4. Implementation Guidelines..... 16**
 - 4.1 Mail Producers using intelligent printers/enclosers 16
 - 4.2 Mail Producers using a production control system 17
 - 4.3 Mail Producers using sortation software that has been Mailmark barcode enabled 18
 - 4.4 Mail Producers using sortation software that is not Mailmark barcode enabled 18
 - 4.5 Mail producers using existing Consolidation Machines..... 19
- 5. Upload Process Description..... 20**
 - 5.1 Upload Process Overview 20
- 6. Web Service Method Details 23**
 - 6.1 Web-service Versions..... 23
 - 6.2 Web-service Login 24
 - 6.3 Poster Upload WSDL..... 24
 - 6.4 Example XML Request/Response Structures 25
- 7. Web Service Method Definitions 27**
 - 7.1 CreateManifest() web method 27
 - 7.2 CreateBatch() web method 29
 - 7.3 AppendToBatch() web method 30
 - 7.4 RemoveItemsFromBatch() web method 30
 - 7.5 SubmitBatch() web method 31
 - 7.6 CancelBatch() web method 32
 - 7.7 RescheduleBatch() web method..... 32



7.8	ReviewManifest() web method.....	33
7.9	ConfirmManifest() web method.....	33
7.10	ReviewUploadActivity() web method.....	34
7.11	ReviewAllUploadActivity() web method (<i>only in Poster Upload 2</i>).....	34
7.12	RetrieveActiveSupplyChains() web method.....	35
7.13	RetrieveAllActiveSupplyChains() web method (<i>only in Poster Upload 2</i>).....	35
8.	Web Service URL & Connection Strategies.....	36
8.1	Web Service URL.....	36
8.2	Compression.....	37
8.3	Disaster recovery.....	38
9.	eMHS Interface Testing.....	39
9.1	eMHS Testing.....	39
9.2	Customer Test Environment.....	40
9.3	Customer Live Environment.....	41
10.	Data Structures.....	44
10.1	eManifest Data Structure.....	44
10.2	The Batch data structure.....	44
10.3	The Mailmark Item data structure.....	45
10.4	The Supply Chain item structure.....	52
11.	OPTIONAL Fields in eMHS for Mailmark Reporting.....	53
11.1	Optional Fields - Mailmark Reporting.....	53
12.	Web Method Error codes and messages.....	54
12.1	Web Method Error codes and messages.....	54
13.	Frequently Asked Questions.....	58
13.1	Error Handling.....	58
13.2	Supply Chain Q&A.....	59
13.3	Upload Process Q&A.....	60
13.4	eManifest Q&A.....	60
14.	Appendices.....	61
14.1	Appendix A.....	61
14.2	Appendix B.....	62

Royal Mail, the cruciform, Royal Mail Advertising Mail, Sustainable, Royal Mail Publishing Mail, Royal Mail Business Mail, Royal Mail Mailmark and Mailmark are trade marks of Royal Mail Group Ltd. © Copyright Royal Mail Group Ltd 2015. All rights reserved. Royal Mail Group Limited, registered in England and Wales, number 4138203, registered office: 185 Farringdon Road, London, EC1A 1AA



1.0 Introduction

1.1. Purpose

The purpose of this document is to provide implementation guidelines for customers wanting to submit eManifests to Royal Mail which are required when using the Royal Mail Mailmark® barcode option. It is designed to provide visibility of the eManifest Handling System (eMHS) customer upload interface to aid customers plan their development of Mailmark® barcode related systems.

1.2. Intended Audience

This document is intended for Mail Producers intending to integrate their production control systems with Royal Mail for the purposes of handling Royal Mail Mailmark barcode mailings, and for third party suppliers interested in updating their software to support the upload of item level data to the eManifest interface.

1.3. Scope

This document describes the high level implementation of the Mailmark barcode eManifest interface which is provided through a web service. It does not describe the Mailmark barcode format, service requirements or terms and conditions surrounding engagement with the program that is delivering the Mailmark barcode option or the terms and conditions relating to the Mailmark barcode enabled services.

This document does not cover bag or vehicle manifests for Network Access Carriers.

1.4. Document Structure

This document is divided into the following areas:-

Process Overview	An overview of the process for uploading eManifests
Implementation Guidelines	Description of the implementation approach
Upload Process Detail	Detailed description of the upload process
Test Facilities and Approach	Overview of the eManifest submission test facilities
eManifest Definition	A definition of the fields that constitute an eManifest
Web Service Specification	The eManifest upload web service specification
Common Questions	Answers and clarifications to frequently asked questions
Appendices	eManifest submission timelines and new added functionality



2.0 Key Features

Royal Mail has introduced services that use a Royal Mail Mailmark barcode. This requires the Mail Producer to apply a Mailmarkbarcode to each mail piece, and provide an eManifest to accompany the mailing.

Each item of mail carries a unique item number within the Mailmark barcode, so that when Royal Mail receives the mail piece, it can be read when it is processed and checked against the eManifest, in order that Royal Mail can provide additional information regarding the successful processing of the item.

2.1. Supply Chain

Each Mailmark barcode enabled mailing is recorded against a Supply Chain, which consists of the Participants involved in the preparation and handling of that mail, including the Mail Originator of the mailing, the Mail Producer (responsible for printing and enclosing the mail pieces), the Bill Payer (the account holder responsible for paying Royal Mail), and the Carrier (responsible for collecting and conveying the mailing from the Mail Producer, whether Royal Mail or a DSA Carrier).

Supply Chains are identified by a **Supply Chain ID**, which is requested online from Royal Mail, and will need to be quoted within the eManifest and barcode. Details on how new Supply Chains are setup and maintained will be provided by the Royal Mail Mailmark team.

The Supply Chain ID is a numeric value of varying length:

- 2D barcodes: 7 digits
- 4-state barcode L: 6 digits
- 4-state barcode C (for Consolidators): 2 digits

Mailmark mailings cannot be prepared without knowing the Supply Chain ID that the mailing belongs to, so it is important that these are requested in advance.

When for instance a Mailing House takes on a new client, it is important that a new Supply Chain ID is requested from Royal Mail at least 24 hours before the first mailing for that client is due to be prepared.

It is assumed that the Mail Producer will usually be responsible for providing Royal Mail with the eManifest, as it needs to reflect the mail produced. The Mail Producer will be a member of the Supply Chain that is printing and enclosing the mail. However the eManifest can be uploaded by any Participant within the Supply Chain.

Note: For clarity subsequent sections of this implementation guide assume the Mail Producer will be uploading the item eManifest, but other members of the Supply Chain can upload the eManifest provided they have registered to do so. If there is more than one Participant in the Supply Chain registered to upload eManifests, there should be careful agreement about who is performing activity against a particular Supply Chain on a particular day.



As the Supply Chain defines the Mail Producer that is preparing the mail, it is **non-transferable** between Mail Producers. If a mailing is transferred from one Mail Producer to another, it is effectively a new mailing against a different Supply Chain ID.

It is essential that the correct Supply Chain ID is used. Failure to do so may lead to the wrong Participants being able to review reports or the wrong Bill Payer being invoiced.

The Supply Chain is made up of the following **Participants**:

Participant	Role
Mail Originator	<p>This is the Participant in a Supply Chain on whose behalf the Mailmark barcode items are produced and delivered.</p> <p>This is commonly the customer that commissioned the mailing.</p>
Mail Producer (Mailing Agent)	<p>This is the Participant in a Supply Chain responsible for producing (including printing and enclosing) the Mailmark barcode items.</p> <p>This is commonly known as the Mailing House, fulfilment house or print site that is physically printing the mail.</p>
Carrier	<p>This is the Participant in a Supply Chain responsible for carrying the Mailmark barcode items to Royal Mail's Mail Centres.</p> <p>This is either:</p> <ul style="list-style-type: none"> - Royal Mail, where Royal Mail is performing the collection and delivery of the mail; or - A Network Access (DSA) Carrier, where the mail is being handed over to Royal Mail for final mile delivery.
Bill Payer / Poster	<p>This is the Participant in a Supply Chain responsible for paying Royal Mail, and against whose account the mailing will be billed.</p>



A Participant may be fulfilling one or more of these roles in any particular mailing, so for instance the following are examples of common scenarios:

Scenario	Mail Originator	Mail Producer	Carrier	Bill Payer
A poster ('Acme Inc.') performing a mailing that they print themselves, collected by Royal Mail, against their own account	Acme Inc.	Acme Inc.	Royal Mail	Acme Inc.
A mailing house ('Print & Co') performing a mailing on their own account via Royal Mail.	Print & Co	Print & Co	Royal Mail	Print & Co
A mailing house (Print & Co') performing a mailing on a client's account ('Acme Inc.') via Royal Mail.	Acme Inc.	Print & Co	Royal Mail	Acme Inc.
A mailing house (Print & Co), performing a mailing on a client account (Acme Inc.), collected by a DSA carrier (Logistics Ltd) prior to final delivery by Royal Mail	Acme Inc.	Print & Co	Logistics Ltd	Acme Inc
A mailing house (Print & Co), performing a mailing on a DSA carrier account (Logistics Ltd.), collected by a DSA carrier (Logistics Ltd) prior to final delivery by Royal Mail	Acme Inc.	Print & Co	Logistics Ltd	Logistics Ltd
A carrier (Logistics Ltd.) consolidating and sorting mail on behalf of a number of clients and mailing houses prior to final delivery by Royal Mail	Logistics Ltd	Logistics Ltd	Logistics Ltd	Logistics Ltd

2.2. eManifest

A separate eManifest will be generated for each day Mailmark items are being despatched, encompassing all items within all mailings performed against that Supply Chain from that Mail Producer that day.

Each eManifest can be uploaded to include one or more Batches of mail, in order to reflect production activity. This is to enable a poster to manage the generation of the eManifest in a manner that best suites the nature of their production process and capabilities of their production control system.



2.3. Batches

The Mail Producer/uploader can choose to upload all the mail for a Supply Chain for a particular day within a single 'Batch', or can upload the eManifest as multiple Batches of mail, that can reflect individual jobs for that client, cells within the same mailing, or work being produced on different enclosing machines.

Each batch can contain mail for a single Supply Chain only, and all Batches for the same Supply Chain on the same date must be included within a single daily eManifest for that Supply Chain.

For each job that a Mail Producer may handle, it can be uploaded to the eManifest Handling Service (eMHS) as one or more Batches of Mailmark barcode items, where each batch contains mail for a single class, product and format of mail for a single Supply Chain, via either the Non-Regulated (Retail) or Network Access (Wholesale) channel.

Batches can be uploaded in various ways. Likely scenarios include:-

Approach	Description
Single mailing per day	If the Mail Producer has all of the items for a particular Supply Chain in a single address file, then the Mail Producer may decide to upload the file as a single Batch.
Multiple jobs per day	If there are multiple jobs being despatched on the same day, then it is possible to upload each job as its own Batch, as each job is enclosed.
Multi-cell mailings	If a mailing consists of multiple cells that are being despatched on the same day, then each cell can be uploaded as a separate Batch.
Separate print jobs	If the Mail Producer is using intelligent mail enclosers, or a production control system, then a mailing may be distributed across multiple enclosers as separate print jobs, in which case each individual print job can be loaded as a separate Batch in order to reflect production activity.

Whether a Mail Producer wishes to upload the eManifest to include one or many Batches will have no impact on the processing of mail by Royal Mail, or any subsequent reporting or management information that may be available to the Mail Producer or other Participants in the Supply Chain. The process to upload in Batches is provided to make it easier for a Mail Producer to ensure that the uploading of eManifests for Mailmark barcode mailings can fit seamlessly into the normal production process.

Note: Each Batch can only contain a single class, product and format of mail for a single Supply Chain, via either the Non-Regulated or Network Access channel.

3.0 Process Overview

3.1 Submitting an eManifest to Royal Mail

The standard process for uploading an eManifest to Royal Mail is as follows:

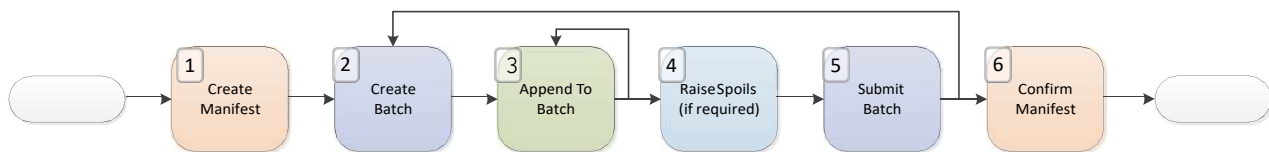

Step	Activity	Description
1	Create an eManifest	Open a new eManifest with Royal Mail for each Supply Chain that the Mail Producer intends to despatch Mailmark mail for each day.
2	Create a Batch	Create a new Batch associated with the eManifest for that Supply Chain. Note - Multiple Batches can be created on the eManifest.
3	Upload the Mailmark items within the Batch	Upload the individual Mailmark barcode item details to Royal Mail for each Batch within the eManifest.
4	Raise any Spoils	Raise any 'spoils' if required - i.e. items that were originally uploaded as part of the Batch, but where the item has not been printed and enclosed successfully, and therefore will not be posted.
5	Submit the Batch	Submit the Batch, indicating that no further changes to the Batch are expected. Note - All Batches must be submitted before the eManifest is confirmed.
6	Confirm the eManifest	This marks the eManifest for a particular Supply Chain as complete. All Batches must have been submitted or cancelled and no further changes to the eManifest are possible.

If the Mail Producer wishes to upload multiple Batches within the same eManifest, then steps 2 to 5 may be repeated as often as necessary, provided step 6 has not yet been performed.

Batches can be uploaded up to 28 days in advance of the handover date.

A Deferred Retail Mailing will require its own unique deferred mailing SCID.

[Note: Deferred Retail functionality is not currently in use].

3.2 Step 4 - Raising 'Spoils' for a Batch

It is possible that during the printing or enclosing process, items that are part of the mailing may be misprinted or damaged, and therefore will not be posted. In this instance the item may originally have been included in an eManifest, but now needs to be removed.

To support this, as each item of Mailmark barcode mail is uniquely identified, it is possible for the 'spoilt' items within the Batch to be advised to Royal Mail via the 'spoils' web service method, in which case the items will be marked on the eManifest as not being posted. This ensures that these items do not appear as 'not machine processed' on the report subsequently generated.

Where a customer is using an intelligent encloser or production control system, then the recording of spoils may be automated, depending on the equipment used.

Spoils can be recorded against the mailing prior to the point at which the eManifest is confirmed.

3.3 Step 5 - Submitting a Batch of Mailmark items

Once the Mail Producer has established that the Batch has been uploaded correctly, and has recorded any spoils, then the Batch should be submitted. This identifies that there is no further change expected to this Batch of Mailmark items. It is essential that all items are uploaded correctly to the Batch. If items are not loaded up they will still be read during processing and Royal Mail may invoice the Bill Payer for them.

Submitting a Batch establishes that the Batch is complete and no further change is expected. Each Batch must be submitted (or cancelled) before the eManifest can be confirmed.

3.4 Step 6 - Confirming the eManifest

Once all the Batches for a Supply Chain have been uploaded to Royal Mail and submitted, then the overall eManifest can be confirmed for that Supply Chain for that date.

It is not possible to confirm an eManifest until all Batches associated with that eManifest have been submitted. Once an eManifest is confirmed, it is marked as complete and no further changes can be made.

The actions that result from submitting the eManifest depend on the Carrier that will be collecting the mail.



The Mail Producer should continue to complete the appropriate collection documentation for Royal Mail or the Carrier involved.

It is important that the eManifest is confirmed otherwise the handling of Mailmark barcode items passed to Royal Mail may be affected.

Confirming the eManifest creates that day's Consignment for the Supply Chain in question.

A manual OBA Sales Order will be required for each Mailmark mailing (unless customers are setup and using ASOG).

A Sales Order is then created for all the items within that manifest (if setup). The status of this Sales Order generation can be monitored by calling the *ReviewUploadActivity()* web method.

eManifest batch submission (involving two separate Supply Chains)

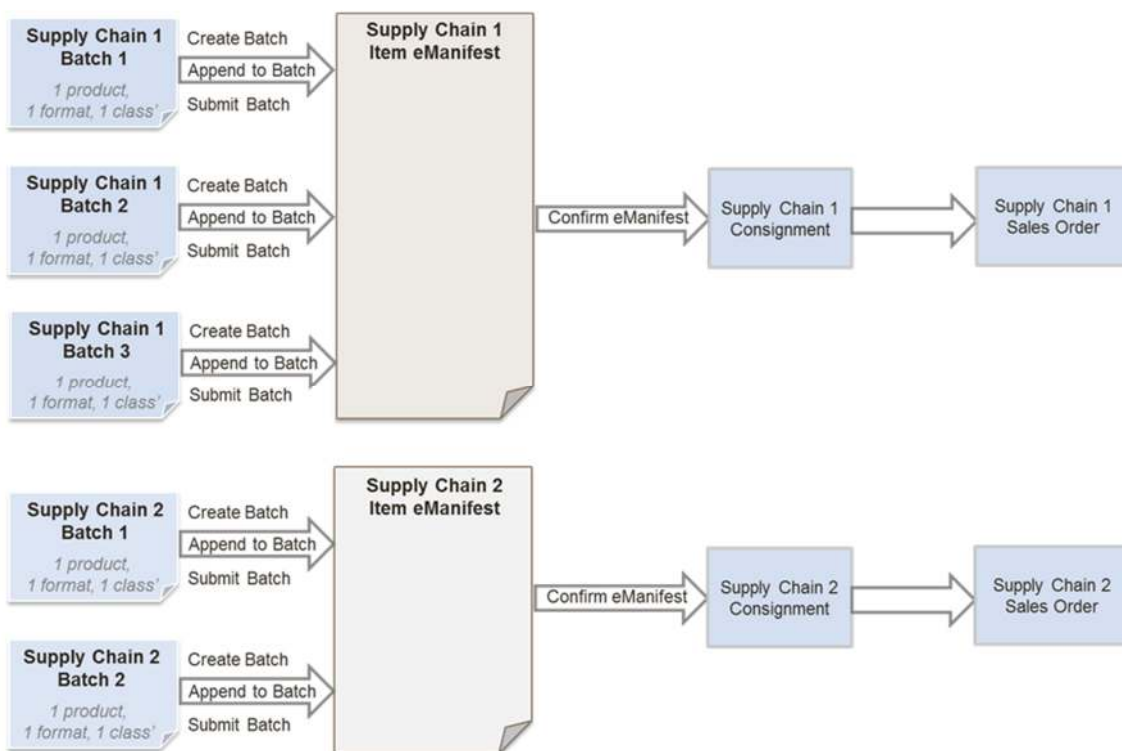

3.5 Timings

Royal Mail Retail Supply Chains

eManifests for Royal Mail Retail Supply Chains can be submitted (confirmed) on the same day as the mailing is handed over. The deadline for confirming **Royal Mail Retail eManifests is configured to 9.30pm on the submission date specified in the eManifest.** At this time, any remaining open eManifests will be automatically confirmed and closed to further Batch submissions.

Wholesale (Network Access) Supply Chains

eManifests for Wholesale (Network Access) Supply Chains using Standard Mail must be confirmed the day before the mail is handed over to Royal Mail. **The deadline for confirming these eManifests is configured to 11.30pm on the submission date specified in the eManifest**

Network Access Supply Chains using Premium Mail can confirm the eManifest on the same day as the mailing is handed over to Royal Mail. **These eManifests must be confirmed by 11.30pm on the submission date specified in the eManifest.** At this time, any remaining open eManifests will be automatically confirmed and closed to further Batch submissions.

Consolidator Supply Chains

eManifests for Consolidator Supply Chains which are specifically defined as Consolidator eManifests, and can be submitted (confirmed) on the same day as the mailing is handed over to Royal Mail. **The deadline for confirming Consolidator eManifests will be configured to 5am on the submission date specified in the eManifest.** At this time, any remaining open eManifests will be automatically confirmed and closed to further Batch submissions.

Royal Mail Deferred Supply Chains [Note: Deferred Retail functionality is not currently in use].

A new type of Supply Chain has now been introduced specifically for Royal Mail Deferred Mailings. A Deferred Mail eManifest and a non-deferred mail eManifest can be submitted on the same day as they will have separate Supply Chains. Deferred Mail eManifests must contain both a deferred batch collection date (the day the mail is passed to Royal Mail) and a handover date (the day the mail is released into the Royal Mail network). There must be no more than 28 days and no less than 7 days between these two dates specified in the eManifest.

Descriptor in Retail User Guide	Descriptor in eMHS Technical Guide	Example
Handover Date	Deferred Batch Collection Date	Mail collected from Mail Producer on Wednesday 10 September
Delivery Start Date	Handover Date	Delivery commences on Monday 21 September

Note: to clarify, **confirming** an eManifest irrevocably submits it to Royal Mail. The submission date declared in the eManifest is the date the eManifest will be confirmed and submitted to Royal Mail.

An empty eManifest (with no data) will also automatically confirm at the appropriate time.

3.6 Other Actions

Whilst the above describes the primary actions that a Mail Producer needs to undertake to upload an eManifest, there are additional actions that may be taken to ensure that the eManifest for a Supply Chain accurately reflects the physical mail being collected.

3.6.1 Cancelling Batches

In the event that a Batch of Mailmark barcode items have been uploaded to Royal Mail, but are not subsequently going to be collected, then it is now possible to cancel the Batch, even if the Batch has been submitted (as long as the eManifest has not been confirmed). In this case the Mailmark barcode items uploaded as part of that Batch are removed from the eManifest.

Note that if the mailing is subsequently going to be regenerated and handed over, once cancelled from an eManifest it will have to be uploaded as a new Batch.

3.6.2 Rescheduling Batches

In the event that a Batch of Mailmark barcode items have been uploaded to Royal Mail, but are not subsequently going to be collected that day, then it is possible to reschedule the collection to a later date (as long as the eManifest has not been confirmed).

If a mailing is rescheduled to a later date, then it is removed from the current eManifest, and associated with the eManifest for the subsequent date. By rescheduling the mailing the need to re-upload the Batch is avoided. The Batch can be deferred for a maximum of two days from the current date.

Batches can be rescheduled more than once but the handover date must not exceed ten days from the original upload. The new eManifest must be associated with the same Supply Chain.

Deferred Mail Batch Rescheduling [Note: Deferred Retail functionality is not currently in use].

The Deferred Batch Collection Date is validated when the eManifest is created. However, a batch can be rescheduled onto a different eManifest which will be handed over up to 10 days after the original eManifest.

Therefore, when a Deferred Batch is rescheduled, its Deferred Batch Collection Date will be validated against the new eManifest's handover date and rejected if it is within 7 days of (or more than 28 days of), the new eManifest's handover date.

Example: eManifest 1 is created with a Handover Date of the 8th March, Batch 1 is created on eManifest 1, with a Deferred Batch Collection Date 1st March. Then, Batch 1 is rescheduled onto eManifest 2, which has a Handover Date of the 3rd March: this would be rejected as the Deferred Batch Collection Date is now only 2 days before the eManifest Handover date.

3.7 eManifest Submission Options

Please see Appendix A for the options available for the timescales of eManifest submission.

Important Note:-

Unique ITEM IDs

Please note that an Item ID must remain unique for at least 90 days after the handover date against which it was previously used.

You must not re-use an Item ID within a Supply Chain (during this period) as this will interfere with your Mailmark reporting.

4.0 Implementation Guidelines

The approach taken to generating eManifests may depend on the nature of the Mail Producer’s production process, equipment used and production equipment used. The eManifest upload facilities have been designed to support a variety of upload approaches.

4.1 Mail Producers using intelligent printers/enclosers

Where a Mail Producer has invested in intelligent printers/enclosers, then depending on the manufacturer and capabilities of the device, the manufacturer may choose to support direct upload of eManifests directly from the printer/encloser itself.

With this approach, the address list will be passed to the intelligent printer/encloser, which will be responsible for applying the Mailmark barcode to the mail piece, and generating the eManifest. In this scenario the intelligent printer/encloser may either generate an output item file, for uploading to Royal Mail using a third party upload tool, or the manufacturer may choose to incorporate the upload of the item details directly to Royal Mail from the printer/encloser, either as the items are printed, or at the end of the print run.

If a Mail Producer has production equipment capable of following this approach, then it is likely that the best implementation approach is to upload item level data to Royal Mail in Batches that reflect the print jobs assigned to each printer/encloser. For instance, if a large mailing is split across 4 printer/enclosers then each printer/encloser will generate its own Batch of items for upload to Royal Mail.

Intelligent enclosers are more likely to have the capabilities to detect spoiled items. Depending on the manufacturer, the registering of those spoils against the Batch may be managed by the printer/encloser, or generated as an output spoils file that will need to be uploaded to Royal Mail using a third party upload tool.

Intelligent Printers/Enclosers

Intelligent enclosers upload batch to EIB at the end of each print job.

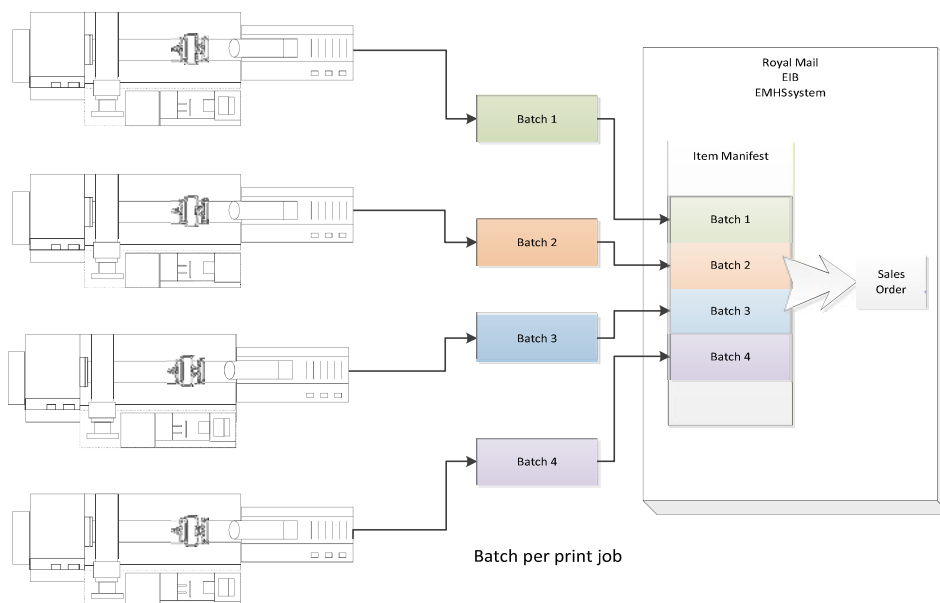

4.2 Mail Producers using a production control system

Where a Mail Producer has implemented a production control system to manage multiple enclosers, depending on the supplier of the production control system software, job workflow and automated spoils re- queuing may be facilities supported by the production control system. In this instance the creation of Batches of items and identification of any resulting spoils may be facilities that production control system software suppliers incorporate within their production control system Software.

Under this approach, the production control system software may generate Batches of items that reflect the allocation of print jobs to printers/enclosers, or it may generate Batches of items based on the mailings being managed by the production control system software,

Production control system software may also interrogate the production enclosers, detect spoils and automatically re-queue items for re-print. In this case the production control system software should be able to generate the appropriate spoils information for upload to Royal Mail.

It is likely that production control system software will be updated to support the automatic uploading of items to Royal Mail at the appropriate time, as part of the job workflow management within the production control system.

Production Control System

Customer Production Control System manages mailings, uploads batches to EIB

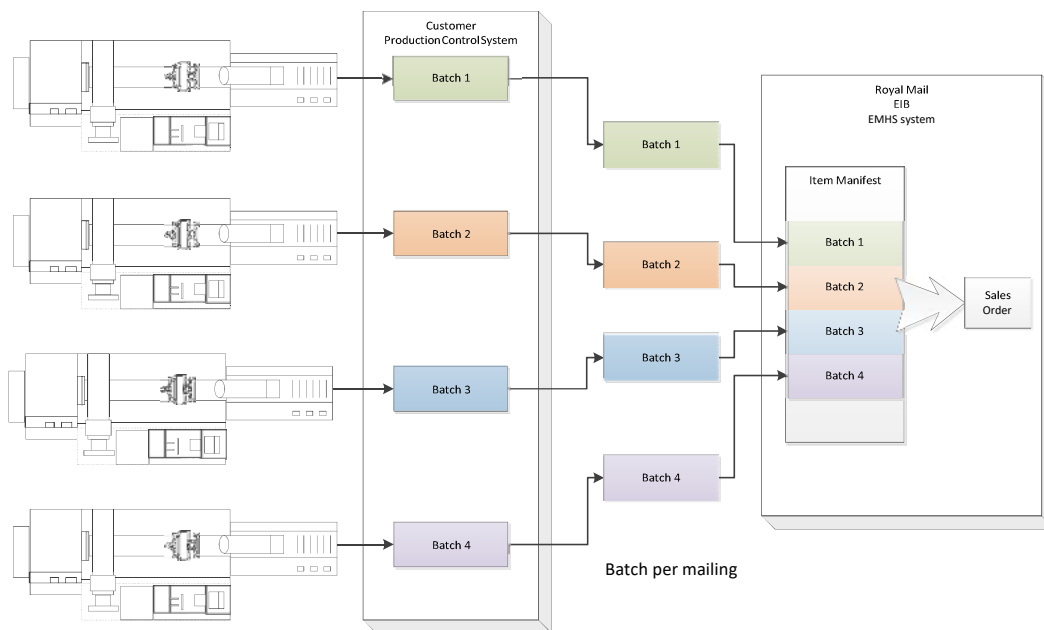

4.3 Mail Producers using sortation software that has been Mailmark barcode enabled

Where a Mail Producer has third party sortation software to manage address sortation, it is possible that the sortation software supplier will incorporate the creation of the eManifest as an output of the address sortation process, and embed the required information for the Mailmark barcode item in the sorted address file.

This approach lends itself to Mail Producers with traditional enclosers with limited communication capability. In this scenario the Batch is likely to represent the job that has been mail sorted in its entirety.

Given that the mailing data sorting process may well be performed several days before the mailing is printed and enclosed, the Mail Producer will need to hold onto the eManifest until at least it is within 2 days of the handover date, as eManifests cannot be uploaded prior to this point.

Because of the potential delay between data sorting an address file, and enclosing/dispatching of the mailing, it is likely that the upload of the Mailmark Batch will be performed using a separate upload application, which may be provided by the sortation software supplier or be available from third-party software suppliers.

4.4 Mail Producers using sortation software that is not Mailmark barcode enabled

Where a Mail Producer is using existing sortation software that has not been made 'Mailmark-barcode enabled', then the address list may have been through a traditional sorting process, but it has not been augmented with information to facilitate generation of the Mailmark barcode item, or the generation of an eManifest.

In this scenario, which is likely to occur in the early stages of the introduction of Mailmark, then the Mail Producer may need to use a third party application to 'Mailmark-barcode enable' a mail sorted address list and generate the required Mailmark barcode outputs. It is likely that any such third party application will also provide facilities to upload the subsequent Mailmark barcode mailing to Royal Mail when the mailing is due to be despatched.

Poster manages jobs manually, used third party software to generate EIB compliant manifest and upload to EMHS

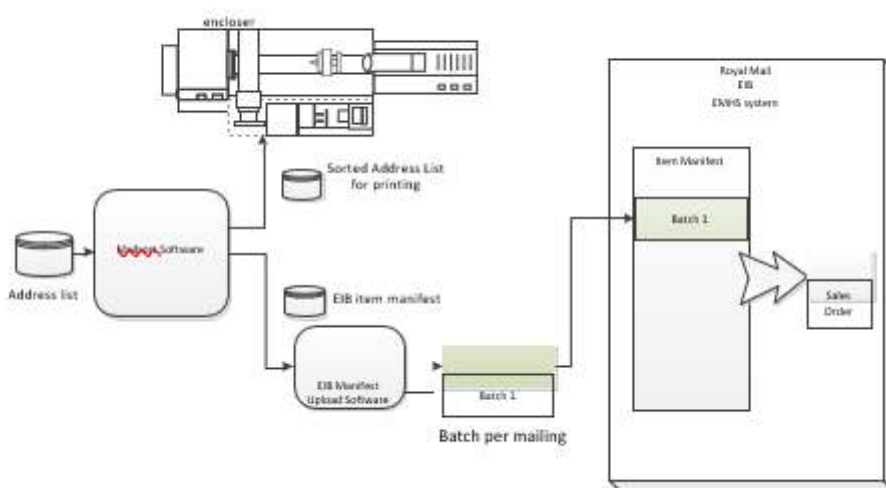

4.5 Mail producers using existing Consolidation Machines

Where a Mail Producer is utilising mail sortation and consolidation equipment to prepare unsorted mail for handover to Royal Mail or a DSA carrier, then the output of this consolidation machine will need to be Mailmark enabled, and uploaded to Royal Mail.

As consolidated mail will need to carry a Mailmark to identify it when it is processed through the machine, the mail consolidation manufacturer is likely to have engaged with Royal Mail during the Mailmark Programme to 'Mailmark barcode enable' their equipment.

It is likely that when using a consolidation machine, eManifests are likely to be generated in Batches that represent each clear down of the machine.

Given that the consolidation process is likely to take place close to the time of despatch, it is possible that the consolidator equipment will also provide the facility to automatically upload item level data to the eManifest.

If this is not the case, or where consolidation equipment that has not been 'Mailmark barcode enabled, then provided that the consolidator can provide an item level output file that incorporates the unique item identifier applied to the mail piece. Then a third party tool may be available to take this item level output and generate and upload the item level data to the eManifest.

5.0 Upload Process Description

The steps outlined below will be undertaken via a series of web service calls. This section describes these processes in further detail, to aid software suppliers and equipment manufacturers to implement the upload of eManifests to Royal Mail. The details of the web-service methods and the structure of the eManifest itself are described in later sections of this document.

5.1 Upload Process Overview

For each job that a Mail Producer may handle, it can be uploaded to the eMHS as one or more Batches of Mailmark barcode items, where each Batch containing mail for a **single class, product, format and (in Poster Upload 2 only) container type of mail for a single Supply Chain**, via either the Non-Regulated or Network Access channel.

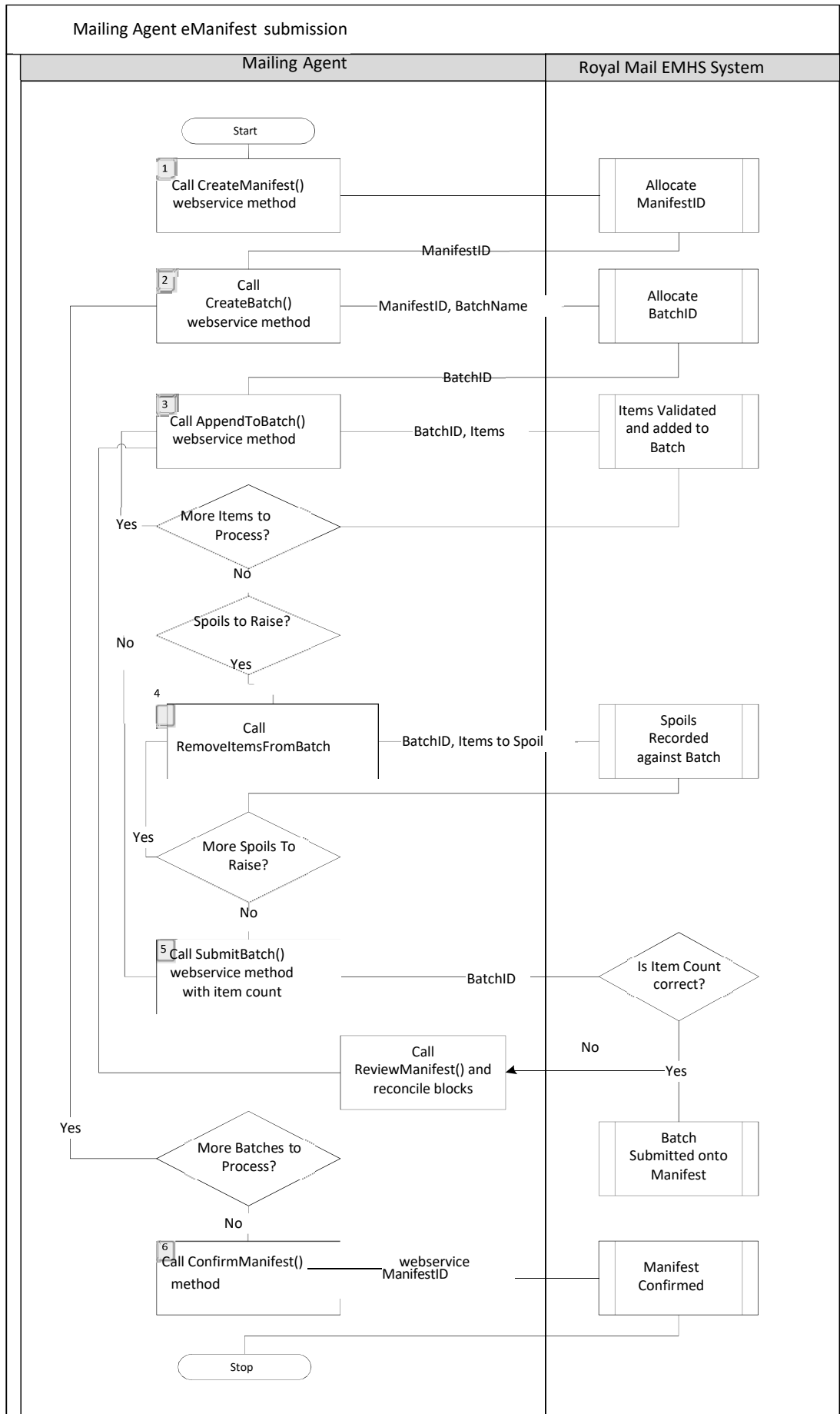

Step 1 - eManifest creation

The Mail Producer will initially call the *CreateManifest()* web service method to receive an eManifest ID for the specified Supply Chain ID and handover date.

Steps 2 & 3 - Batch upload

The Mail Producer will then call the *CreateBatch()* web service method to receive a unique BatchID for that Batch within a specified eManifest ID, and then repeatedly call the *AppendToBatch()* web service method to add additional blocks of 1,000 items to the Batch. The ID of the block will be returned.

Step 5 - Batch submission

Once a Batch has been uploaded to the eMHS, it can be submitted onto that day's eManifest by calling the *SubmitBatch()* web service method.

The number of items in the Batch must be specified by the poster and this will be checked against the number of items received.

Alternatively if the Mail Producer subsequently chooses to cancel the mailing because it is no longer going to be dispatched, then the Batch can be cancelled with the *CancelBatch()* web service method.

If the Batch has been delayed and is not going to form part of today's handover, then the Batch can be rescheduled to the next Working Day using the *RescheduleBatch()* method.

Step 4 (optional) - Recording of spoils

Prior to the eManifest being confirmed, if a Mail Producer wishes to amend a Batch, as a result of the items originally advised on the Batch not being posted, (*e.g. the item has not been printed successfully*) then it can be advised as a spoil against that Batch by calling the *RemoveItemsFromBatch()* web method.

Each call returns a BlockID, this can be used to determine which blocks need to be re-uploaded in case of a discrepancy in item count when submitting the Batch.

Step 6 - eManifest confirmation

All Batches uploaded against a Supply Chain for a specific date are collated by the eMHS onto a single eManifest, and when complete the uploaded Batches can then be submitted. Once submitted the eManifest can be confirmed by calling the *ConfirmManifest()* web method. This freezes all Batches present on the eManifest, and prevents any further Batches being uploaded or amended against that Supply Chain for that date. Any subsequent Batches must be uploaded against the next day's eManifest.

6.0 Web Service Method Details

6.1 Web-service Versions

The original web services (known as Poster Upload) restricted the eManifest upload functionality to the Mail Producer of the Supply Chain. This has now been amended so that any Participant in a Supply Chain can upload the eManifest. Also, the SAP account number which is a mandatory field for Royal Mail (Retail) mailings is now 'optional' for Network Access Supply Chains.

As a result, an additional version of the web services (known as Poster Upload 2) has been created.

This latest version of the web services supports additional features including Container Based Pricing, Deferred Mailing and Automated Sales Order Generation. [Note: Deferred Retail functionality is not currently in use].

To enable this, a 'Container Type' field has been added as well as other optional fields which are relevant for the new added functionality.

This version also has two additional web service calls relating to any Participant in the Supply Chain uploading the eManifest:

- *RetrieveAllActiveSupplyChains()* enables a Participant to retrieve all active Supply Chains which they are a participant within.
- *ReviewAllUploadActivity()* to return details of eManifest uploads against all Supply Chains that the Participant is either the Mail Producer or Carrier for, regardless of which participant in the Supply Chain performed the eManifest upload.

Existing customers may continue to upload using the original web service, however we suggest customers transition to the new web service to access the additional features available.

All new Mailmark customers should develop against the Poster Upload 2 version and use the new web services associated with this endpoint.

Please note: if you have already developed your system based on the previous documentation but would now like to move to the enhanced web services (poster upload 2), you may need to create additional attributes for ContainerType, Deferred Mailing and Auto Sales Order Generation (see section 10.3. Item data structure).

6.2 Web-service Login

The mailing upload web services exposed by eMHS are accessed by HTTPS. In order to access the web service, the primary contact at the Mail Producer (or alternative participant uploader) will be provided with a web-service login username and password on registration (see section 9). This username and password will need to be specified in all web-service calls.

Any software application or production equipment looking to upload item level data to eManifests will need to retain this username and password, and it needs to be quoted in all web-service method calls.

The web service username and password is specific to that Participant, and must not be passed onto any other mailer or third party. These login details are intentionally different to those for the eMHS web portal (User Interface), as well as any OBA or royalmail.com user logins, and are designed to support inter-system communication only between the Mail Producer systems and Royal Mail's eMHS platform.

The Mail Producer will also be allocated a Participant ID and an initial Supply Chain ID to enable setup on the system and can be requested from the Mailmark Mailmark team.

Royal Mail Security Standard for Web Services

The version of .NET supported by the Mailmark eMHS Poster Upload Interface is .NET version 3.5 and above. The eMHS system complies with Royal Mail's security standards for web services. Customers using legacy client web services (including .Net 2) will need to update to the latest web services in order to connect to the eMHS.

6.3 Poster Upload WSDL



















The WSDL below describes the latest (current) version of the eMHS Poster Upload web service (Poster Upload 2):



< Embedded File - Double Click to Open

6.4 Example XML Request/Response Structures

For customers using the latest Poster Upload - End Point 2

Web service Method	Example Request	Example Response
RetrieveActiveSupplyChains()	 RetrieveActiveSupplyChainsRequest.xml	 RetrieveActiveSupplyChainsResponse.xml
CreateManifest()	 CreateManifestRequest.xml	 CreateManifestResponse.xml
CreateBatch()	 CreateBatchRequest.xml	 CreateBatchResponse.xml
AppendToBatch()	 AppendToBatchRequest.xml	 AppendToBatchResponse.xml
RemoveItemsFromBatch()	 RemoveItemsFromBatchRequest.xml	 RemoveItemsFromBatchResponse.xml
SubmitBatch()	 SubmitBatchRequest.xml	 SubmitBatchResponse.xml
CancelBatch()	 CancelBatchRequest.xml	 CancelBatchResponse.xml
RescheduleBatch()	 RescheduleBatchRequest.xml	 RescheduleBatchResponse.xml
ReviewManifest()	 ReviewManifestRequest.xml	 ReviewManifestResponse.xml

Web service Method	Example Request	Example Response
ConfirmManifest()	 ConfirmManifestRequest.xml	 ConfirmManifestResponse.xml
ReviewUploadActivity()	 ReviewUploadActivityRequest.xml	 ReviewUploadActivityResponse.xml
ReviewAllUploadActivity()	 ReviewAllUploadActivityRequest.xml	 ReviewAllUploadActivityResponse.xml
RetrieveAllActiveSupplyChains()	 RetrieveAllActiveSupplyChainsRequest.xml	 RetrieveAllActiveSupplyChainsResponse.xml

For convenience, The WSDL and example XML files are attached to this PDF (See paperclip icon in the menu bar)



7.0 Web Service Method Definitions

7.1 CreateManifest() web method

In order to upload eManifests, the first action that any upload application needs to do is create an eManifest for a specified mailing date for a specified Supply Chain.

Request Parameters			
Name	Format	Example	Description
ParticipantID	Integer (8)	12345678	The Participant ID for the participant creating the eManifest, typically this is the Mailing Agent
SupplyChainID	string(7)	1234567	The assigned Supply Chain ID
SubmissionDate	date	22/01/2015	The intended date of submission of the eManifest (DD/MM/YYYY)
HandoverDate	date	24/01/2015	The declared date the mail will be handed to Royal Mail (DD/MM/YYYY)
SapAccountNo	string(10)	987654321	The Royal Mail Account No that belongs to the Payer for the Supply Chain, for which the mailing will be billed to (this may be blank for Network Access Supply Chains).
PostingLocation	string(10)	9000123456	The posting location
YourDescription	varchar (40)	HSD Mailing	OPTIONAL (New Field) - Free text field for Auto Sales Order Generation (ASOG) to enable customer to assign a description to eManifest submitted via eMHS
CustomerReference	varchar (35)	"e12345 Seasonal Customer Promo"	OPTIONAL (New Field) - Field for Auto Sales Order Generation (ASOG) consisting of eManifest ID and Your reference. Data in this field is passed through to OBA to tie eManifest ID to a Sales Order. Format - ("e"<eManifestID><Single Space><Customer Reference>)
DeferredBatchCollectionDate	date	30/01/2015	Deferred Mail Supply Chain ONLY (New Field) - Represents the date that deferred mail should be collected (DD/MM/YYYY) [Note: Deferred Retail functionality is not currently in use].

Response			
Name	format	Example	Description
ManifestID	Integer	12345678	The eManifest ID to be used when uploading Batches
SubmissionDeadline	date	27/01/2015 21:00	The deadline date for the eManifest submission
Errorcode	integer	0	Returned error status, 0 indicates success,
ErrorMessage	string(255)	"Not permitted"	Textual description of any error encountered.

Notes:

- eManifests can only be created up to 28 days in advance of the handover date.
- The eManifest ID returned is specific to that Supply Chain on that date. Mail for other Supply Chains cannot be uploaded against that eManifest ID. A separate eManifest must be requested.
- The eManifest ID is specific to the date specified. If mail is to be dispatched on a different day then a new eManifest ID needs to be created.
- If an existing eManifest has already been created for the specified Supply Chain and date, then that eManifest ID will be returned.
- The deadline for confirming eManifests are defined in section 6.4.
- The SAP Account number is no longer mandatory for Network Access and Consolidator Supply Chains



7.2 CreateBatch() web method

This web method will be used at the start of each upload, to identify the mailing being uploaded, and request a new Batch ID within the specified eManifest ID.

This information will be used by the calling system to associate any subsequent calls to the upload service with this Batch.

If the specified eManifest ID does not exist or does not match the specified Supply Chain then an error will be returned to the calling system.

Request Parameters			
Name	format	Example	Description
SupplyChainID	string(7)	1234567	The assigned Supply Chain ID
ManifestID	Integer (10)	12345678	The eManifest ID to associate the Batch with
BatchReference	string(30)	Batch 100	The Batch reference
YourReference	char (12)	HR Mailing	OPTIONAL - For Auto Sales Order Generation (ASOG). This reference is customer defined for your own purposes.
ConsignmentReferenceNumber	varchar (3)	123	OPTIONAL -For Auto Sales Order Generation (ASOG). Used to determine Volume Related Discounts for Mail sort products. Required format: NNN
MagazineCode	varchar (5)	A1234	CONDITIONAL - <u>Required for Publishing Mail</u> , if customers are Auto Sales Order Generation (ASOG) enabled. Format: ANNNN. (Must be 5 characters).
Issued	varchar (8)	Xmas 15	OPTIONAL - <u>For Publishing Mail</u> , if customers are Auto Sales Order Generation (ASOG) enabled. Issue ID allows customers to internally track mailing campaigns.
DepartmentID	numeric (10)	2000001000	OPTIONAL - For Auto Sales Order Generation (ASOG). Numeric value between 2000000000 - 3999999999.
Response			
Name	format	Example	Description
BatchID	integer	23456789	The identifier for this Batch
Errorcode	integer	0	Returned error status, 0 indicates success,
ErrorMessage	string(255)		Textual description of any error encountered.



7.3 AppendToBatch() web method

This web method will allow the posters systems to upload a block of Mailmark item records to the eMHS system, and append those items to the specified Batch upload. Each call will append up to 1,000 items to the specified Batch.

Request Parameters			
Name	format	Example	Description
BatchID	Integer (7)	23456789	The identifier for this Batch
BlockCount	integer	23	A numeric customer-supplied reference which will be associated with the block of items. This allows uploaded blocks to be tracked in case the response message with the BlockId id is lost.
Items	Array of Items	N/A	Up to 1000 item records to append to the Batch
Response			
Name	format	Example	Description
BlockId	long	12345678765	The ID of the created block
ResponseCode	integer	0	Returned error status, 0 indicates success,
ErrorMessage	string(255)		Textual description of any error encountered.

7.4 RemoveItemsFromBatch() web method

This web method will allow the poster’s systems to upload a block of Mailmark barcode items that should be removed from the specified Batch. The matching Mailmark item records within the specified Batch will be marked as spoils – i.e. they are not expected to be handed over by the poster for delivery. The items will still be declared in the eManifest to Royal Mail’s Enterprise Reporting, with the item status set to indicate that this item was removed from the eManifest. Spoilt items will not however be included in the summarisation for Automatic Sales Order Generation.

Request Parameters			
Name	Format	Example	Description
BatchID	integer (7)	23456789	The identifier for this Batch
Items	Array of Items	N/A	Up to 1,000 item records to be marked as spoils. Only the EIBItemid (called ItemID in Endpoint2) needs to be provided.

Response			
Name	Format	Example	Description
BlockId	long	12345678765	The ID of the created block of removed items
ResponseCode	integer	0	Returned error status. 0 indicates success,
ErrorMessage	string(255)		Textual description of any error encountered.

7.5 SubmitBatch() web method

This web method enables a poster's system to mark a Batch as being confirmed onto the eManifest. Once a Batch has been submitted, no further change is permitted against that Batch. The poster will advise the total number of items within the Batch, and eMHS will check this against the information uploaded to ensure that no uploads are missing. If there is a discrepancy then the call will fail.

Request Parameters			
Name	format	Example	Description
BatchID	Integer (7)	23456789	The identifier for this Batch
TotalItemCount	integer	50000	The total number of items in the Batch
Response			
Name	format	Example	Description
ResponseCode	integer	0	Returned error status. 0 indicates success,
ErrorMessage	string(255)		Textual description of any error encountered.



7.6 CancelBatch() web method

This web method enables a poster’s system to cancel a previously uploaded Batch, provided the eManifest that the Batch is associated with has not been confirmed.

Request Parameters			
Name	format	Example	description
BatchID	Integer (7)	23456789	The identifier for this Batch
Response			
Name	format	Example	description
ResponseCode	integer	0	Returned error status, 0 indicates success,
ErrorMessage	string(255)		Textual description of any error encountered.

7.7 RescheduleBatch() web method

This web method enables a previously uploaded Batch to be rescheduled from the current mailing date onto an eManifest for a later mailing date (up to 28 days in advance).

Request Parameters			
Name	format	Example	description
BatchID	Integer (7)	23456789	The identifier for this Batch
NewManifestID	integer	34567890	The new eManifest ID
Response			
Name	format	Example	description
ResponseCode	integer	0	Returned error status, 0 indicates success,
ErrorMessage	string(255)		Textual description of any error encountered.

7.8 ReviewManifest() web method

This web method enables a poster’s system to retrieve information against a specific eManifest ID, including the Batches that have been submitted onto that eManifest. It also indicates whether all processing for the specified eManifest has been performed and the eManifest has been confirmed.

Request Parameters			
Name	format	Example	description
ManifestID	integer	34567890	The eManifest ID
Response			
Name	format	Example	description
Manifest	eManifest	N/A	Detail of the eManifest and its associated Batches
ResponseCode	integer	0	Returned error status. 0 indicates success,
ErrorMessage	string(255)		Textual description of any error encountered.

7.9 ConfirmManifest() web method

This web method enables a poster’s system to submit an eManifest, and any Batches that are contained therein, by specifying the eManifest ID. This creates the set of Batches for the Supply Chain on the specified date. Once confirmed, no changes can be made to an eManifest, and it cannot be deleted. When the Auto Sales Order Generation functionality is available, this could initiate the request of a SAP Sales Order.

Request Parameters			
Name	Format	Example	Description
ManifestID	integer	34567890	The eManifest ID
Response			
Name	Format	Example	Description
ResponseCode	integer	0	Returned error status. 0 indicates success,
ErrorMessage	string(255)		Textual description of any error encountered.

7.10 ReviewUploadActivity() web method

This web method enables a poster’s system to review all upload activity performed by that Participant in the last 24 hours, for diagnostic purposes. It details the Batches that have been uploaded, whether they have been submitted onto an eManifest, and whether the eManifest has been confirmed to form that day’s set of Batches for the associated Supply Chain.

Request Parameters			
Name	Format	Example	description
Response			
Name	Format	Example	description
eManifests	eManifest array	N/A	Array of eManifests and their associated Batches
ResponseCode	integer	0	Returned error status, 0 indicates success,
ErrorMessage	string(255)		Textual description of any error encountered.

7.11 ReviewAllUploadActivity() web method (only in Poster Upload 2)

This web method is similar to the ReviewUploadActivity() web method described above. Whereas ReviewUploadActivity() only returns eManifests uploaded by that Participant, the ReviewAllUploadActivity() web method will return all upload activity for Supply Chains that the Participant is either the Mail Producer or the Carrier for, regardless of which Participant in the Supply Chain performed the eManifest upload.

Request Parameters			
Name	Format	Example	Description
Response			
Name	Format	Example	description
eManifests	eManifest array	N/A	Array of eManifests and their associated Batches
ResponseCode	Integer	0	Returned error status, 0 indicates success,
ErrorMessage	string(255)		Textual description of any error encountered.

7.12 RetrieveActiveSupplyChains() web method

Returns a list of active Supply Chains that the Participant is identified as the Mail Producer for.

Request Parameters			
Name	format	Example	Description
Response			
Name	Format	Example	Description
SupplyChains	Array of Supply Chains	N/A	An array of valid Supply Chains accessible for the Mail Producer.
ResponseCode	integer	0	Returned error status, 0 indicates success,
ErrorMessage	string(255)		Textual description of any error encountered.

7.13 RetrieveAllActiveSupplyChains() web method (*only in Poster Upload 2*)

Returns a list of active Supply Chains that the Participant is involved in, regardless of the participant's role within the Supply Chain.

Request Parameters			
Name	format	Example	Description
Response			
Name	Format	Example	Description
SupplyChains	Array of Supply Chains	N/A	An array of valid Supply Chains accessible for the Participant
ResponseCode	integer	0	Returned error status, 0 indicates success,
ErrorMessage	string(255)		Textual description of any error encountered.

8.0 Web Service URL & Connection Strategies

8.1 Web Service URL

Mailing Agents will access the eMHS SOAP-based web services using HTTPS over the public internet.

Prior to going live, Mailing Agents will need to test their solution interface. Royal Mail provides a customer test environment to aid development of eManifest creation and upload software (see section 9).

For the test environment and separately the live environment, the participant will be given details of how to register on the eMHS User Interface (on-line portal), creating a username and password (see section 9). Registration and activation will provide them with a web service username and password specific to that Participant ID, which must be passed in each web service call.

Target	URL
eMHS upload URL - Customer Test environment	https://CustomerTest.RM-manifest.com
eMHS upload URL - Live	https://RM-manifest.com

Web service – poster upload 2

TEST environment URL	https://customertest.rm-manifest.com/PosterUpload2/PosterUpload.svc/service
LIVE environment URL	https://rm-manifest.com/PosterUpload2/PosterUpload.svc/service

8.2 Compression

There are additional endpoints defined for the upload services to allow for uncompressed or compressed eManifest uploads (Gzip or Deflate compression methods are supported).

For posters to use compression, the following steps need to be taken:

- 1) Choose a compression method, GZip or DEFLATE
- 2) Compress the message envelope with the chosen compression method
- 3) Add an appropriate HTTP Header
 - a. For GZip, use application/x-gzip
 - b. For DEFLATE, use application/x-deflate
- 4) Use the appropriate endpoint as defined above.

Note that responses from the server will also use the specified compression method, and will have to be decompressed accordingly.

These compression methods are available in both test and live environments, and with both the latest version and the original version of the web services.

Web Service – Poster Upload 2

	TEST environment URL	LIVE environment URL
GZip compressed	https://customertest.rm-manifest.com/PosterUpload2/PosterUpload.svc/compressGZip	https://rm-manifest.com/PosterUpload2/PosterUpload.svc/compressGZip
DEFLATE compressed:	https://customertest.rm-manifest.com/PosterUpload2/PosterUpload.svc/compressDeflate	https://rm-manifest.com/PosterUpload2/PosterUpload.svc/compressDeflate

8.3 Disaster recovery

In the event that the eMHS DR environment is invoked, then a DNS re-routing will be applied to this URL to ensure that it directs to the correct currently active host. This URL is purposefully configured with a short DNS keep-alive so that any changes to the routing for this URL is rapidly cascaded to internet users.

It is possible that a Customer’s internal network may ignore DNS keep-alive settings and have been configured with an excessively long DNS retention period, which will result in the Customer’s systems not receiving DNS changes to this URL until the customers firewalls refresh their DNS routing tables. In order to cater for this scenario, the Uploader can access the target URL for the Primary and DR environments directly if required, ensuring that the customer can still continue to upload eManifests to eMHS whilst their Firewall DNS retention period expires. *(During normal operation the web services at the DR environment are disabled and redirect to the primary environment).*

The Direct URLs are as follows:-

Target	URL
eMHS Primary site	https://primary.RM-manifest.com
eMHS DR site	https://dr.RM-manifest.com

The eMHS Upload web service is a SOAP-based web service secured over HTTPS. Additionally the calling system must specify a username and password as part of each web-service call in order that the uploader can be authenticated as a Participant in the specified Supply Chain.

Please Note:

The version of .NET supported by the Royal Mail Mailmark eMHS Poster Upload Interface is .NET version 3.5 and above. This is to ensure that the eMHS system complies with Royal Mail’s security standards for web services.

9.0 eMHS Interface Testing

9.1 eMHS Testing

Before a Mail Producer can undertake Mailmark barcode mailings, they must perform some tests, to ensure that:

- They are able to produce and upload a valid eManifest
- They are able to print mail with a Mailmark barcode which Royal Mail can read and interpret

Customers, software suppliers and equipment manufacturers will be provided with access to a test environment which can be used for testing purposes whilst enhancing existing software/equipment to be Mailmark compliant, or when developing eManifest upload applications.

This customer-facing test environment will not replicate the performance of the Royal Mail's live systems, and customers wishing to test against this test service will be provided with test Supply Chain IDs and test user credentials to access the service.

This customer test environment is specifically designed to allow developers to implement and test code against the published Web-service definition. Whilst the availability of this test environment cannot be guaranteed, any periods where this environment is likely to be unavailable will be notified on a dedicated test environment status URL.

Once a customer or software supplier has reached the point where they have developed their software they can contact the Royal Mail Mailmark team and request access to the live Mailmark environment to undertake the Quality Assurance process.

The Quality Assurance process is optional but highly recommended.

The Royal Mail Mailmark team will then allocate you a Participant ID and Supply Chain IDs, and grant access to the live eMHS platform. This will enable you to request the live web service login ID's for your Participant ID, and authenticate your email address for eManifest submission notifications.

Please note that all Supply Chain IDs and Participant IDs used in the customer test environment are invalid in the live eMHS environment. Only live Supply Chain IDs that you are a Participant in can be used in the live eMHS environment.



9.2 Customer Test Environment

The Customer test environment is available for customers and mail software suppliers to aid development of their software to support eManifests. This environment is designed for interface testing only, and does not support any report or management information functionality.

In order to test against the customer test environment, The Mail Producer or software supplier wishing to test will need to register on the customer test environment.

eMHS Test Registration process:

Step	Description
1	Register with Royal Mail Mailmark team. Please contact Mailmark@royalmail.com for further details.
2	Mailmark team request the creation of test Participant ID and Supply Chains and forwards the email to the customer. <i>Note that this test Participant ID and test Supply Chains can only be used in the Customer test environment and are not valid in the live environment.</i>
3	Navigate to https://customertest.rm-manifest.com/RegistrationUI/
4	Click on the 'Register Now' link
5	Enter the Participant/Mailing Agent Name (Mailing House or eManifest Uploader), Participant ID and Supply Chain ID exactly as detailed in the email, along with your email address.
6	eMHS will send a registration email to this email address, which will contain an embedded link specific to you. Click on this link within 1 hour of registration to confirm your email address and set up a password.
7	Registration will generate your webservice username and password (separate to above details registered on the User Interface). Ensure you keep a record of these, they will need to be recorded in your upload software in order to upload eManifests into eMHS.
8	eMHS will create 10 test Supply Chains to be used with the test Participant ID, and assign a webservice username/password for testing against the customer test web services. These details can be viewed through the eMHS Customer Test online User Interface, and should be used for testing purposes in the customer test environment. <i>Note that this test Participant ID and test Supply Chains can only be used in the customer test environment and are not valid in the live environment.</i>
9	If you wish a particular email address to be notified of test confirmation of eManifests, then use the eMHS customer test UI to specify an additional (secondary) email contact to be notified about eManifest confirmation.

The customer test environment has the following restrictions:-

- ParticipantID for customer test is not valid in the live environment.
- Test Supply Chain IDs are not valid in the live environment.
- Webservice username/passwords are only valid in the customer test environment and are not valid for the live environment..
- Primary contact login details registered in the customer test environment are not copied into the live environment, and will need to be separately registered.
- No information is passed from the customer test environment to management reports or the Royal Mail Portal; it is for interface testing only.
- The customer test environment is a low volume environment for interface testing only, and does not reflect performance of the actual live system.

9.3 Live eMHS Environment

Access to the live eMHS environment is controlled by Royal Mail and is driven by the Participant Registration process managed by the Royal Mail Mailmark team.

When a Mail Producer (or other Participant wishing to upload eManifests) has tested against the customer test environment to a point that they are comfortable that they can generate eManifests correctly, then they should contact Royal Mail in order to undertake the Quality Assurance process and register for the ability to make Mailmark mailings.

Royal Mail's Mailmark team will then set the Participant up and allocate a live Participant ID. They will also setup any Supply Chain IDs which are required.

The Mailmark team will email the Participant with a welcome email that contains a link to the registration page on the eMHS. The Participant then needs to register their details onto the eMHS system 24 hours after the initial request.



Step	Description
1	Mailmark team allocates a Participant their live Participant ID and initial Supply Chain ID and sends them a welcome message.
2	Participant clicks on the embedded link within the welcome message, and is taken to the live eMHS registration page.
3	Enter the Participant ID and Supply Chain ID and Company Name. If these match the details received by the Mailmark Management System the user will be permitted to register on the eMHS system.
4	Enter the email address of the Primary Contact.
5	eMHS will send a registration email to this email address, which will contain an embedded link specific to that user. Click on this link within 1 hour for registration to confirm your email address and set up a password.
6	On login to the on-line portal eMHS will then provide you with a management User Interface that will enable you to view settings specific to handling of your eManifests, and set the users that will be notified when an eManifest is confirmed.
7	Registration in step 5 will automatically generate your webservice username and password (separate to the User Interface details). Ensure you keep a note of these. They will need to be recorded in your upload software in order to upload eManifests into eMHS.
8	When a participant registers they are set as the Primary Contact. It is possible to set another contact as the Primary Contact. There can only be one Primary Contact at a time. If you wish an additional email address to be notified of when eManifests are confirmed, then use the UI to specify an email address, and the type of notification that the user wishes to receive.

Test and live access details

Test site	
Registration address	https://customertest.rm-manifest.com/RegistrationUI
Participant ID	TEST PID issued to customer: __
Initial SCID for registration	TEST SCID issued to customer: _ _ _ _ _
eMHS username	Primary customer email address input by customer: _____
eMHS password	As chosen by customer: _____
User Interface (online portal)	https://CustomerTest.RM-manifest.com
Web service call username	Automatically generated and emailed to customer following registration and activation on TEST eMHS: _____
Web service call password	As above: _____
Poster upload web service end point	https://customertest.rm-manifest.com/PosterUpload2/PosterUpload.svc/service

Live site	
Registration address	https://rm-manifest.com/RegistrationUI/
Participant ID	LIVE PID issued to customer: __
Initial SCID for registration	LIVE SCID issued to customer: _ _ _ _ _
eMHS username	Primary customer email address input by customer: _____
eMHS password	As chosen by customer: _____
User Interface (online portal)	https://CustomerTest.RM-manifest.com
Web service call username	Automatically generated and emailed to customer following registration and activation on LIVE eMHS: _____
Web service call password	As above: _____
Poster upload web service end point	https://rm-manifest.com/PosterUpload2/PosterUpload.svc/service

10.0 Data Structures

This section defines the structure of each Mailmark item record, its containing Batch, and the eManifest.

10.1 eManifest Data Structure

Attribute Name	Format	Description
ManifestID	integer	The eManifest ID
SubmissionDate	Datetime	The submission deadline
HandoverDate	date	The handover date
SupplyChainId	string(7)	The Supply Chain ID
AgentParticipantName	string(30)	Name of the Mail Producer
OwnerParticipantName	string(30)	Name of the Mail Originator Participant
CarrierParticipantName	string(30)	Name of the Carrier Participant
PayerParticipantName	string(30)	Name of the Bill Payer Participant
SAPAccountNo	string(10)	The SAP Account number (not required for Network Access)
SAPSalesOrderNo	string(10)	The SAP Sales Order number
ManifestStatusDesc	string(30)	Status description for the eManifest
ManifestStatusCode	integer	Status code for the eManifest
Batches	Array of Batch objects	The contained Batches

10.2 The Batch data structure

Attribute Name	Format	Description
BatchID	integer	The BatchID that the item is within.
BatchReference	string(30)	The Batch name used by the Mail Producer to identify a Batch of Mailmark items.
ItemCount	integer	The number of items on the Batch
RemovedItemCount	integer	The number of spoilt items in the Batch
BatchStatusDesc	string(30)	Status description for the Batch
BatchStatusCode	integer	Status code for the Batch
Blocks	Array of longs	The blocks saved against the Batch [ReviewManifest only, not included in ReviewUploadActivity]

10.3 The Mailmark Item data structure

(Each Mailmark item record is approximately 959 bytes in size.)

Note: The item data structure contains fields which may need to be included as part of the data record file.

Mandatory – *This field must be included.*

Optional – *This field may be included, or can be omitted.*

Conditional – *This field is dependent on the service type (see field description for details); can be omitted if not relevant.*

Attribute Name	Format	Optionality	Description
EIBItemID	Integer(8)	Mandatory	The mail item ID to identify the individual item that has been printed by the bulk mail customer. This is maintained on a per Supply Chain ID and sequentially incremented by the generating system, padded with leading zeros. Note: The Item ID must remain unique for at least 90 days after the handover date against which it was previously used.
Product	Char(3)	Mandatory	The declared product for the mail item matching the 3 Character Code within SAP OBA
Format	Char (1)	Mandatory	The declared format for the mail item: 0 = Null 1 = Mailmark Letter 2 = Mailmark Large Letter 3 = Reserved for future use 4 = Parcel 5...9 = not in use A...Z = not in use This value must match the declared product. Please note: it is a mandatory requirement to select the 'format'
Class	Char(1)	Mandatory	The declared class for the mail item: 0 = Null/Test 1 = 1c (Retail) 2 = 2c (Retail) 3 = 3c (Retail) 4 = Premium (Retail Publishing Mail) 5 = Deferred (Retail) – For use with Deferred mail Supply Chains only. 6 = Not in use 7 = Not in use 8 = Premium (Network Access) 9 = Standard (Network Access) "E" – Economy (Network Access) "A to D" and "F to Z" – Spare This value must match the declared product.



Attribute Name	Format	Optionality	Description
Weight	Integer	Mandatory	Unit item average weight for the item or letter or packet in grams, rounded up to the nearest gram (5 digit numeric).
ContainerType	Char(10)	Optional	The Container Type, used for Container Based Pricing: BAG or TRAY As applicable to the product used. Note: For <u>Network Access mailings</u> , if Container Type is not specified eMHS will enter a value based on the product code being used. For <u>Retail mailings</u> , it will enter a default value of 'BAG'. Please note that this may affect the price of the mailing in OBA.
<i>*note: new field relevant only to Poster Upload 2 (see section 6).</i>			
MailType	Char(1)	Mandatory	The declared mail type for the mail item: 0 = Null/Unknown 1 = Advertising 2 = Business 3 = Fulfilment 4 = Publishing 5 = Business Reply 6 = Freepost 7 = Election Mail 8 = Spare 9 = Consolidated A to Z = Spare
MailSubType1	Char(1)	Optional	The declared sub mail type for the mail item e.g. bank statement Null if not specified by the mailing agent 0 = Null
MailSubType2	Char(1)	Optional	The declared sub mail type for the mail item e.g. bank statement Null if not specified by the mailing agent 0 = Null
MailSubType3	Char(1)	Optional	The declared sub mail type for the mail item e.g. bank statement Null if not specified by the mailing agent 0 = Null
MailSubType4	Char(1)	Optional	To identify whether this is a Media Agency Posting Null if not specified by the mailing agent 0 = Null (not a Media Agency Posting) 1 = Media Agency Posting
AdvertisingAttribute1	Char(1)	Optional	To identify any trans-promotional advertising attributes: 0 = Null
AdvertisingAttribute2	Char(1)	Optional	To identify any trans-promotional advertising attributes:

Attribute Name	Format	Optionality	Description
			0 = Null
AdvertisingAttribute3	Char(1)	Optional	To identify any trans-promotional advertising attributes: 0 = Null
AdvertisingAttribute4	Char(1)	Optional	To identify whether the posting is participating in any Incentives / Promotions 0 = Null (not an Incentive/Promotion) 1 = ACG (Advertising Content Growth) (Previously SFG – Scheme for Growth) 2 = TIS (Testing and Innovation Scheme) 3 = FTU (First Time User Incentive) 4 = AVC (Advertising Volume Commitment) 5 = PVC (Publishing Volume Commitment)
Machinable	Char(1)	Mandatory	The declared machinability of the mail item: E = Mailmark N = <i>Reserved for future use</i> Note: 'E' must be selected for Mailmark General Large Letters and Parcels.'
AddressLine1	Varchar(60)	Optional	Mail Item Address Line 1 as printed on the first address line of the mail item (i.e. the recipient or business name must not be used in this field)
AddressLine2	Varchar(60)	Optional	Mail Item Address Line 2
AddressLine3	Varchar(60)	Optional	Mail Item Address Line 3
AddressLine4	Varchar(60)	Optional	Mail Item Address Line 4
AddressLine5	Varchar(60)	Optional	Mail Item Address Line 5
AddressLine6	Varchar(60)	Optional	Mail Item Address Line 6
AddressLine7	Varchar(60)	Optional	Mail Item Address Line 7
AddressLine8	Varchar(60)	Optional	Mail Item Address Line 8
AddressLine9	Varchar(60)	Optional	Mail Item Address Line 9
NumberOfAddressLines	Int(1)	Mandatory	The number of address lines declared by the Mailing Agent which were printed on the Mailmark Item. 0 - 9 Lines (if not known, use a default value of 4 lines)
Postcode	Char(7)	Mandatory	The declared Postcode of the PAF® address of the item. Inland Postage contains the following characters. Area (1 or 2), District (1 or 2), Sector(1) and Unit(2). If the full postcode is not available please enter as much of the postcode as possible and pad the remainder of the fields with either 7 zeros OR 7 space characters
DPS	Char(2)	Mandatory	The declared Delivery Point Suffix of the PAF® address of the Mailmark Item. If the DPS is NOT available then either the value of '9Z' is to be used or the field should be blank (empty).
CampaignName	Varchar(30)	Optional	Optional Customer Specified Campaign Name. Null if not specified by the Mail Producer

Attribute Name	Format	Optionality	Description
			*Used in Mailmark customer reporting <i>(Enables 90 days' worth of data to be linked together).</i>
Department	Varchar(30)	Optional	Optional Customer specified Department Name. Null if not specified by the Mail Producer *Used in Mailmark customer reporting
MailerId	Integer (3 digit numeric)	Optional	Mailing House ID (QMP Number). The Mailer ID is held as an attribute of the Posting Location but is only populated if the Posting Location is a Mailing House. A null value indicates that the customer account is the mailer. Null if not specified by the mailing agent 0 = Null
MailOriginatorSubDivisionName	Varchar(30)	Optional	Optional Mail Originator Sub Division Name. Null if not specified by the Mail Producer *Used in Mailmark customer reporting = "Job" Report. <i>(Enables 90 days' worth of data to be linked together).</i>
ResellerUsed	Varchar(10)	Optional	The name of the reseller that was the source of the address file. Null if not specified by the Mail Producer
PAFResellerProduct	Varchar(10)	Optional	The resellers product name that was the source of the address file. Null if not specified by the Mail producer
PAFResellerProductVersion	Varchar(4)	Optional	The version of the resellers product that was the source of the address file. Null if not specified by the Mail Producer
PAFVersion	Varchar(4)	Optional	PAF® Version if known. Null if not specified by the Mail Producer
ResponseLicenceNo	Char(6)	Conditional	<u>Future use only.</u> (Only to be used if a unique response barcode is being used). For Response Service licence number under which the response item will be billed. The first 6 characters of the full licence is included i.e. the full licence of AAAA-AABB-BBBB is reduced to AAAAAA.
ResponsePostcode	Char(7)	Conditional	<u>Future use only.</u> (Only to be used if a unique response barcode is being used). The declared Response Service mail item Postcode of the PAF address of the Response Item. Inland Postage contains the following characters. Area (1 or 2), District (1 or 2), Sector(1) and Unit(2).
ResponseDPS	Char(2)	Conditional	<u>Future use only.</u> (Only to be used if a unique response barcode is being used). The declared Response Service mail item Delivery Point Suffix of the PAF address of the Response Item.
ResponseSupplyChain	Varchar(10)	Conditional	<u>Future use only.</u> (Only to be used if a unique response barcode is being used).

Attribute Name	Format	Optionality	Description
			Supply Chain ID for the Response element of the mailing.
ResponseItemID	Integer (8)	Conditional	<u>Future use only.</u> (Only to be used if a unique response barcode is being used). Response Item ID to identify the individual response item that has been printed by the bulk mail customer. This is maintained per Supply ChainID and sequentially incremented by the generating system, padded with leading zeros.
ResponseFormat	Char(1)	Conditional	<u>Future use only.</u> (Only to be used if a unique response barcode is being used). The declared format of the Response Item: 0 = Null 1 = Letter 2 = Large Letter 3 = <i>not in use</i> 4 = Parcel 5...9 = <i>not in use</i> A...Z = <i>not in use</i>
ResponseClass	Char(1)	Optional (dependent on service used)	<u>Future use only.</u> (Only to be used if a unique response barcode is being used). The declared class of the Response Item: 0 = Null/Test 1 = 1c (Retail) 2 = 2c (Retail) 3 = 3c (Retail) 4 = Premium (Retail) 5 = Deferred (Retail) 6 = <i>not in use</i> 7 = <i>not in use</i> 8 = Premium (Network Access) 9 = Standard (Network Access) E = Economy (Network Access) A...D = <i>not in use</i> F...Z = <i>not in use</i>
ResponseMailType <i>(Referred to as Service Type in the Barcode Specification)</i>	Char(1)	Mandatory	0 = Mailmark Letter (Mech) 1 = Mailmark Large Letter (Mech) 2 = <i>reserved for future use</i> 3 = <i>reserved for future use</i> 4 = Parcel 5 = <i>not in use</i> 6 = <i>not in use</i> Null if not specified by the uploader The "ServiceType" value, if supplied, should be as applicable to the product used. The "ServiceType" may be Null or omitted, in which case the default ServiceType for the product shall be used.
RTSService	Char(1)	Conditional	<u>Future use only.</u> (Only to be used if a unique response barcode is being used). Return To Sender service classification:

Attribute Name	Format	Optionality	Description
			0 = Null
RTSPostcode	Char(7)	Conditional	<u>Future use only.</u> (Only to be used if a unique response barcode is being used). The declared Return To Sender Postcode of the PAF address of the mail Item. Inland Postage contains the following characters. Area (1 or 2), District (1 or 2), Sector (1) and Unit(2).
RTSDPS	Char(2)	Conditional	<u>Future use only.</u> (Only to be used if a unique response barcode is being used). The declared Return To Sender Delivery Point Suffix of the PAF address of the mail Item.
SpecialServiceFlag	Char(1)	Conditional	<u>Future use only.</u> (Only to be used if a unique response barcode is being used). The declare special service flag: 0 = Null
SpecialServiceBarcode	Char(10)	Conditional	<u>Future use only.</u> (Only to be used if a unique response barcode is being used). Null if not specified by the Mail Producer.
SPARE1	Char(1)	Optional	JIC Opt-OUT Used to identify whether this posting is to be excluded from JIC reporting of advertising mailings. Attribute Name = SPARE1 Null if not specified by the Mail Producer 0 = Null (JIC Reporting permitted) 1 = JIC Opt-Out (do not include in JIC reporting)
SPARE2	Char(1)	Optional	Mail Information Type ID Null if not specified by the Mail Producer Attribute Name = SPARE2 0/Null = Bulk (Sorted & Unsorted) 1 = International Bulk (Sorted & Unsorted) 2 = Response Services 3 = Business Mail Advanced 4-9 = reserved for future use A = Online Postage B = Meter/Frinking C = Consolidated D-O = reserved for future use P = Poll Cards Q-T = reserved for future use

Attribute Name	Format	Optionality	Description
			U = Business Mail Unsorted V = reserved for future use W-Z Test Purposes Only
SPARE3	Char(1)	Optional	SPARE field (Royal Mail use only) to support future growth. Null if not specified by the Mail Producer 0 = Null
SPARE4	Varchar(6)	Optional	SECTOR CODES (The Mailmark Insight Advertising sector code) If used these codes must be entered as n.n.n or n.n.nn Format is validated on submission and batch will be rejected if this formatting rule is not adhered to. 0 is not a valid entry – if a full sector code is not entered the field should be left blank. Attribute Name = SPARE4
SPARE5	Varchar (6)	Optional	SPARE field (Royal Mail use only) to support future growth. Null if not specified by the Mail Producer 0 = Null
SPARE6	Varchar (10)	Optional	PRODUCT DESCRIPTION (The Mailmark Insight Advertising description) Attribute Name = SPARE6 Null if not specified by the Mail Producer 0 = Null
SPARE7	Varchar (10)	Optional	SPARE field (Royal Mail use only) to support future growth. Null if not specified by the Mail Producer 0 = Null
SPARE8	Varchar (30)	Optional	CARRIER RESERVED FIELD This field is reserved for use by the Network Access Carrier. (where the posting is being performed under a Network Access supply chain) Attribute name = SPARE8
SPARE9	Varchar (30)	Optional	CUSTOMER REFERENCE Meaningful customer reference which will show in item level reporting. Attribute name = SPARE9 Null if not specified by the Mail Producer 0 = Null

Attribute Name	Format	Optionality	Description
			*Used in Mailmark customer reporting
SPARE10	Varchar (50)	Optional	SPARE field (Royal Mail use only) to support future growth. Null if not specified by the Mail Producer 0 = Null

10.4 The Supply Chain item structure

Attribute Name	Format	Description
SupplyChainID	string(7)	The Supply Chain ID
MailingAgentName	string(80)	Mail Producer name
MailOriginatorName	string(80)	Mail Originator name
CarrierName	string(80)	Carrier name
PayerName	string(80)	Bill Payer name
SAPAccount	string(80)	SAP Account
EndDate	date	The End Date set on the Supply Chain (if present)

11.0 OPTIONAL Fields in eMHS for Mailmark Reporting

11.1 Optional Fields - Mailmark Reporting

Customers who submit eManifest files to Royal Mail have the option to include 'customer specified data' to identify their mailings. This data (if submitted to the eMHS) is then visible in the customer's Mailmark reports.

These 'optional' fields are:

- *MailOriginatorSubDivisionName*
- *CampaignName*
- *Department*
- *Spare9*

MailOriginatorSubDivisionName

Customers who populate the "MailOriginatorSubDivisionName" field in eMHS will see that data appear in the "Job Report" tab in the Mailmark reporting portal.

This enables separate eManifests to be linked together in a single report under one job.

CampaignName

Customers who populate the "CampaignName" field in eMHS will see that data appear in the "Campaign Report" tab in the Mailmark reporting portal.

This enables separate eManifests to be linked together in a single report under one campaign.

Department

Optional field in eMHS for customer specified department name, which appears in the Customer's item level Mailmark reports.

SPARE9 (Customer Reference)

Optional field in eMHS for customer specified reference.

Although the attribute name in the eManifest is called 'SPARE9', this will appear as 'Customer Reference' in the Mailmark item level report.

It is recommended that these fields are included as part of your Mailmark software solution to enable the participants, particularly the Data Originator to make meaningful use of the 'exception level' reporting.



12.0 Web Method Error codes and messages

12.1 Web Method Error codes and messages

Web Method	Response code	Message	Description
All	0		Call Success – no issues.
All	503	"Internal Error"	An internal error occurred

CreateManifest	1	"Mail Producer is not involved in this Supply Chain"	The Mail Producer is not involved in the specified Supply Chain
CreateBatch	"	"	"
ConfirmManifest	"	"	"
CreateBatch	2	"Invalid Supply Chain ID"	The supplied Supply Chain ID does not exist or is not valid for the mailing agent
CreateManifest	3	"Invalid SAP Account Number"	Invalid SAP Account Number
CreateManifest	4	"Invalid Submission Date"	Invalid Submission Date
CreateManifest	5	"Invalid Handover Date"	Invalid Handover Date
ConfirmManifest	6	"Invalid eManifest ID"	The supplied eManifest ID does not exist or is not associated with the Supply Chain
RescheduleBatch	"	"	"
ReviewManifest	"	"	"

AppendToBatch	7	Fatal Item Validation Failure	<p>One or more items failed validation of 'Reject' level rules and the block has been rejected.</p> <p>Class Is Required Class Must Be Valid DPS Must Be Valid EIBItem Is Required EIBItem Must Be Less Than Nine Digits EIBItem Must Be Positive Format Code Is Required Format Code Must Be Valid Machinable Is Required Machinable Must Be Valid MailType Code Is Required MailType Code Must Be Valid NumberOfAddressLines Must Be Valid [Not less than zero or greater than 10] Product Code Is Required Product Type Must Match SupplyChain Type ResponseEIBItemID Must Be Less Than Nine Digits Weight Is Required Weight Must Be Positive</p>
---------------	---	-------------------------------	---

AppendToBatch	8	"Items Failed Validation"	One or more items failed validation of 'Report' level rules. The exact response text is "{0} item(s) failed validation" where {0} is a placeholder for the number of items that failed. The block is not rejected.
AppendToBatch	9	"Invalid Batch ID"	Batch ID does not exist or is not associated with the poster
SubmitBatch	"	"	"
CancelBatch	"	"	"
RemoveItemsFromBatch	"	"	"
RescheduleBatch	"	"	"
SubmitBatch	10	"Incorrect Item Count"	The supplied Item Count does not match the number of received items
ConfirmManifest	11	"There are batches associated with this eManifest with are neither submitted nor cancelled"	There are Batches associated with the eManifest with are neither submitted nor cancelled and which have not been rescheduled.
ConfirmManifest	12	"The eManifest has already been confirmed"	The eManifest has already been confirmed
CreateBatch	"	"	"

AppendToBatch	13	"The batch's status does not allow this operation"	The Batch has been submitted or cancelled
SubmitBatch	"	"	"

CancelBatch	"	"	The Batch has already been cancelled
CreateManifest	14	"A Confirmed eManifest already exists for this Supply Chain on this date"	A eManifest already exists for the specified Supply Chain on the specified date, and it has already been confirmed.
AppendToBatch	15	"Too many items"	More than 1,000 items have been submitted in one block
RemoveltemsFromBatch	"	"	"
CreateManifest	16	"The supply chain has been closed"	The specified Supply Chain has an end date which is before the submission date
Confirm eManifest	"	"	"
RescheduleBatch	17	" Batch Reschedule Period Expired"	An attempt has been made to reschedule a Batch to an eManifest which has a handover date more than 10 days later than the Batch's original upload date.
AppendToBatch	18	"Mixed Products Not Allowed"	All blocks in a Batch must contain the same Product, Class and Format
AppendToBatch	19	"Invalid Network Status"	The specified Product code is not valid for the Supply Chain Network
RescheduleBatch	20	"Reschedule Batch Must Be Different eManifest"	The new manifest for a Rescheduled Batch must not be the original eManifest
InvalidProduct	21	"The supplied product code must be valid"	Items must have a valid Product code
AppendToBatch	22	"The supplied format is not valid for the specified product"	Format must be valid for the Product
AppendToBatch	23	"The supplied class is not valid for the specified product"	Class must be valid for the Product
AppendToBatch	24	"The supplied container type is not valid for the specified product"	Container type must be valid for the Product
AppendToBatch	25	"The supplied combination of format and container type is not valid for the specified product"	Format must be valid for the Container type

CreateBatch	26	"The Manifest is not associated with the Supply Chain"	Manifest Id and Supply Chain ID are valid but not associated with each other
CreateManifest	27	"Deferred Mail must have a Batch Collection Date"	A batch collection date must be specified for Deferred Mail
CreateManifest	28	"Invalid Deferred Mail Batch Collection Date"	The batch collection date must be at least 7 and no more than 28 days before the handover date
CreateBatch	29	"The department must be 10 characters long"	If supplied, the Department must be exactly 10 characters
CreateBatch	30	"Issueld is not allowed for Deferred Mail"	Issue ID may not be specified for Deferred Mail
CreateBatch	31	"Magazine Code is not allowed for Deferred Mail"	Magazine Code may not be specified for Deferred Mail
CreateBatch	32	"Magazine Code must be 5 characters long and in the format ANNNN (e.g. A1111)"	The Magazine Code must be 5 characters long and in the format ANNNN (e.g. A1111)
CreateManifest	33	"Batch Collection Date may only be supplied for Deferred Mail"	A Batch Collection Date may only be supplied for Deferred Mail manifests
CreateBatch	34	"Consignment Reference Number must not exceed three characters and must only contain numbers"	If specified, the Consignment Reference Number must not exceed three characters and must only contain numbers
AppendToBatch	35	"Publishing Mail may only be added to a batch that has an Issueld and MagazineCode assigned"	Publishing Mail may only be added to a batch that has an Issue Id and Magazine Code assigned"
AppendToBatch	36	"Only Products with a class of Deferred can be used for Deferred Mail"	Only Products with a class of Deferred can be used for Deferred Mail
AppendToBatch	37	"Products with class Deferred cannot be used on non-Deferred Mail"	Products with class Deferred cannot be used on non-Deferred Mail

13.0 Frequently Asked Questions

13.1 Error Handling

The eMHS database is transactional, meaning that if an error is encountered during processing, the transaction is rolled back.

However, the Internal Error Handling is designed to catch unhandled exceptions that may occur during any state of the process, there is a possibility that an error might occur between successful processing of the request and the response from the web service, which would mean that it is **not** possible to guarantee that none of the data has been committed.

For example this situation could occur:

- Mail Producer calls CreateManifest

The database successfully creates the eManifest and returns the new ID to the web service

- The web service is about to respond with the new eManifest ID, but an unexpected error occurs before it can, so it returns InternalError.

The Mailing Agent is then in the same predicament as if they did not receive the response from the web service due to network or client failure – there is no way to tell from the response if the request has been actioned.

If the client receives an “internal error” or loses connectivity and fails to receive a response, then how to proceed depends on which Web Method was called:

- CreateManifest – subsequent calls to CreateManifest will return any previously created eManifest ID.
- CreateBatch – call ReviewManifest to see if the Batch has been created, if not then re-try the CreateBatch web method.
- AppendToBatch – need to call ReviewManifest to see if the items have been saved against the Batch, by checking the returned list of BlockIDs against the block list held by the client. If the block is missing then re-try the AppendToBatch web method for the missing block.
- RemoveItemsFromBatch – need to call ReviewManifest to see if the items have been saved against the Batch, by checking the returned list of BlockIDs against the block list held by the client. If the block is missing then re-try the RemoveItemsFromBatch web method for the missing block.
- SubmitBatch – check Batch status in ReviewManifest, if the Batch hasn't been submitted, re-try the SubmitBatch web method.
- CancelBatch – check Batch status in ReviewManifest, if the Batch hasn't been cancelled, re-try the CancelBatch web method.
- RescheduleBatch – check Batch status in ReviewManifest, if the Batch hasn't been rescheduled, re- try the RescheduleBatch web method.

- ConfirmManifest - check eManifest status in ReviewManifest, the eManifest hasn't been confirmed, re-try the ConfirmManifest web method.

All other errors listed require the client to correct the content of the web method and to re-try the web method containing the correct data.

13.2 Supply Chain Q&A

Question	Answer
<i>Why do I need a Supply Chain ID in order to undertake a Mailmark barcode mailing?</i>	The Supply Chain ID is created to identify all the Participants involved in preparing the mailing, and is one of the core aspects of the Mailmark barcode. It is used to determine who can upload mailings, who will be charged by Royal Mail, and how visibility of any management information is controlled.
<i>I don't have a Supply Chain ID for one of my clients - how do I get one?</i>	Supply Chain IDs are managed online via royalmail.com. Information on how to request new Supply Chain IDs will be provided during your engagement onto the Mailmark system.
<i>How long does it take to activate a new Supply Chain ID?</i>	It takes 24 hours for a newly requested Supply Chain ID to be available for you to upload eManifests against.
<i>I need to perform a mailing today for one of my clients, but I don't have a Supply Chain ID for them - can I perform the mailing?</i>	No - In order for the mailing to be accepted as a Mailmark mailing it must have a valid Mailmark Supply Chain ID specified to qualify as a Mailmark mailing.
<i>I don't have a Supply Chain ID for one of my clients, but I do have other Supply Chain ID's - can I use that?</i>	No - The Supply Chain ID determines the Royal Mail Account that will be charged for the mailing, and who has visibility of any management information about the mailing. It is critical that it is only used for the client that the Supply Chain ID is assigned to - SupplyChains are <u>not</u> transferable.
<i>My client has given me a Supply Chain ID for another Mail Producer, but wants me to do the mailing - can I use their Supply Chain ID?</i>	No - The Supply Chain ID also determines where the mail is to be collected from. A Supply Chain ID cannot be shared between Mail Producers. SupplyChains are <u>not</u> transferable.

Question	Answer
<i>Why can't I just email Royal Mail the item level data that goes into the eManifest – why do I have to upload it?</i>	The eManifest contains address information, and therefore needs to be kept secure. Emailing address lists would not be a secure method for transferring this information to Royal Mail
<i>Why a web service – why can't I send it to an FTP server?</i>	FTP servers are in common use, but they are not necessarily very secure. Whilst Secure FTP services are available, the transfer time for large files can be result in transfer failures, or slow the internet connection for other users at that site. Providing a webservice means that the eManifests can be 'streamed' up to Royal Mail, in a similar manner to the way 'LoveFilm' and 'Netflix' stream films. This works well for large files, and means that if the poster does not have a fast internet connection it can be 'throttled' so that internet performance for other users isn't adversely affected.
<i>Isn't there a website that I can upload the eManifest to?</i>	No – the upload is designed for system-to-system transfers of data. The file size for an eManifest can be large and therefore uploading via a website could be impractical and time consuming. If you have an eManifest file that you need uploading, it is expected that third party suppliers will provide upload applications that are Mailmark-compliant
<i>Do you recommend any particular upload applications?</i>	No – there are various solutions in the marketplace. Royal Mail cannot recommend individual third party suppliers, but a list of software suppliers providing Mailmark compliant software is available at www.royalmail.com/mailmark .

13.4 eManifest Q&A

Question	Answer
<i>Why do I have to upload an eManifest in Batches?</i>	An eManifest can contain one or more Batches – it is up to the client and Mail Producer to decide how best to use this facility. It's there to make it easier for Mailmark to fit within the mail production process. If you don't want to use Batches, just upload all the Mailmark barcode items within a single Batch but please remember that a Batch must contain items of the same service, format and class.
<i>Why is a Batch uploaded in small blocks of data rather than as one big file?</i>	By breaking the Batch up into smaller blocks of 1,000 Mailmark barcode items, it is easier to stream the item data up to Royal Mail, and problems with transmission are easier to detect. It is also easier for application developers to 'throttle' the transfer to make sure that the transfer of the eManifest information doesn't impact other users.
<i>Why upload in blocks of 1,000 Mailmark barcode items? Why not a larger block size?</i>	The block size has been set at 1,000 items as the optimum size for each block, so that the size of data transferred is under 2Mb, as webservice calls over this size are more likely to time-out.
<i>Can an eManifest be submitted to Royal Mail by more than one Participant in the Supply Chain?</i>	Only one member of the Supply Chain can upload an eManifest against a particular Supply Chain each day. This would normally be the Mail Producer, but can be another Participant in the Supply Chain if required.

14.0 Appendices

14.1 Appendix A

The table below shows the various options available for submitting the eManifest to Royal Mail.

The below is based on a Retail Supply Chain type.

1 eManifest (same SCID)

Possible Options	DAY 1	DAY 2	DAY 3
Option 1	Open eManifest Submission Date Handover Date		
Option 2	Open eManifest Submission Date	Handover Date	
Option 3	Open eManifest Submission Date		Handover Date
Option 4	Open eManifest	Submission Date Handover Date	
Option 5	Open eManifest	Submission Date	Handover Date
Option 6	Open eManifest		Submission Date Handover Date

Options		DAY 1	DAY 2	DAY 3
Option 1	1 st eManifest	Open (<i>eManifest ID 100</i>) Submission Date Handover Date		
	2 nd eManifest	Open (<i>eManifest ID 101</i>) Submission Date	Handover Date	
Option 2	1 st eManifest	Open (<i>eManifest ID 100</i>) Submission Date Handover Date		
	2 nd eManifest	Open (<i>eManifest ID 101</i>)	Submission Date Handover Date	
Option 3	1 st eManifest	Open (<i>eManifest ID 100</i>) Submission Date Handover Date		
	2 nd eManifest	Open (<i>eManifest ID 101</i>) Submission Date		Handover Date
Option 4	1 st eManifest	Open (<i>eManifest ID 100</i>) Submission Date Handover Date		
	2 nd eManifest	Open (<i>eManifest ID 101</i>)	Submission Date	Handover Date
Option 5	1 st eManifest	Open (<i>eManifest ID 100</i>) Submission Date Handover Date		
	2 nd eManifest	Open (<i>eManifest ID 101</i>)		Submission Date Handover Date
Option 6	1 st eManifest	Open (<i>eManifest ID 100</i>) Submission Date	Handover Date	
	2 nd eManifest	Open (<i>eManifest ID 101</i>) Submission Date		Handover Date
Option 7	1 st eManifest	Open (<i>eManifest ID 100</i>) Submission Date	Handover Date	
	2 nd eManifest	Open (<i>eManifest ID 101</i>)	Submission Date	Handover Date
Option 8	1 st eManifest	Open (<i>eManifest ID 100</i>)	Submission Date Handover Date	
	2 nd eManifest	Open (<i>eManifest ID 101</i>)	Submission Date	Handover Date
Option 9	1 st eManifest	Open (<i>eManifest ID 100</i>)	Submission Date Handover Date	
	2 nd eManifest	Open (<i>eManifest ID 101</i>) Submission Date		Handover Date
Option 10	1 st eManifest	Open (<i>eManifest ID 100</i>)	Submission Date Handover Date	
	2 nd eManifest	Open (<i>eManifest ID 101</i>)		Submission Date Handover Date



14.2 Appendix B

Deferred Mail Supply Chain Type

Customers are now able to use Mailmark for their deferred mailings and benefit from Mailmark reporting. Furthermore, customers using the Deferred Mail service will also be able to automatically generate sales orders using Mailmark.

Note: Customers will be issued with a separate Deferred Mail Supply Chain (SCID) for any deferred mailings. [Note: Deferred Retail functionality is not currently in use].

Deferred Mail eManifests must also contain both a Deferred Batch Collection Date (the day the mail is passed to Royal Mail) and a Handover Date (the day the mail is released into the Royal Mail network). There must be no more than 28 days and no less than 7 days between the two dates. A Deferred Mail eManifest and a non-deferred mail eManifest can be submitted on the same day. Non-deferred eManifests cannot use a Deferred Mail Supply Chain and vice versa.

Auto Sales Order Generation

Auto Sales Order Generation (ASOG) is a service offering giving Royal Mail Retail customers (Bill Payer Participant) the ability to automatically generate OBA sales orders as part of eManifest creation. Currently Mailmark customers are required to log into OBA to manually generate sales orders for their eManifests. The capability introduced has removed the need for customers to manually create sales orders.

To support this functionality, optional new fields have been included in this documentation in order to aid your IT development.

Feedback on this guide

If you would like to see additional information included in this specification document or you discover any errors, please contact us at mailmark@royalmail.com.

We welcome your feedback.

